

MX.500.P150

1 - 5 %

5,0
m³/h

Massima portata motore
Maximum motor flow rate



ITA QUOTE (mm) | GB DIMENSIONS (mm)

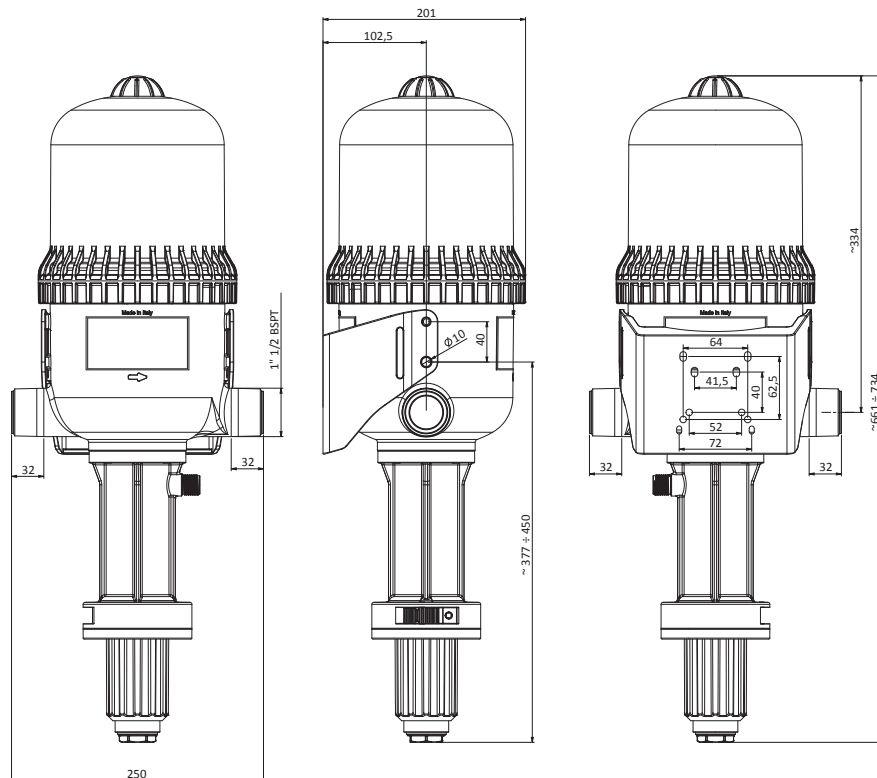

ITA CARATTERISTICHE | GB CHARACTERISTICS

Dosaggio min/max %
Min/Max dosing ratio %

1 - 5 %

Min/Max rapporto dosaggio
Min/Max dosing ratio

1:100 ; 1:20

Max portata motore
Max water flow

5.000 l/h

Componenti plastici
Plastic components

POM, PP, HDPE, PA12

Componenti metallici
Metal components

AISI 316, Duplex

Guarnizioni
Seals

Viton, EPDM

Pressione di lavoro
Operating pressure

0,3 - 8 bar

Massima pressione statica
Max static pressure

10 bar

Temperatura
Temperature

5° - 40° C

ITA Grafico perdite di carico - pompa 1 - 5 %

GB Flow Resistance Graph - pump 1 - 5 %

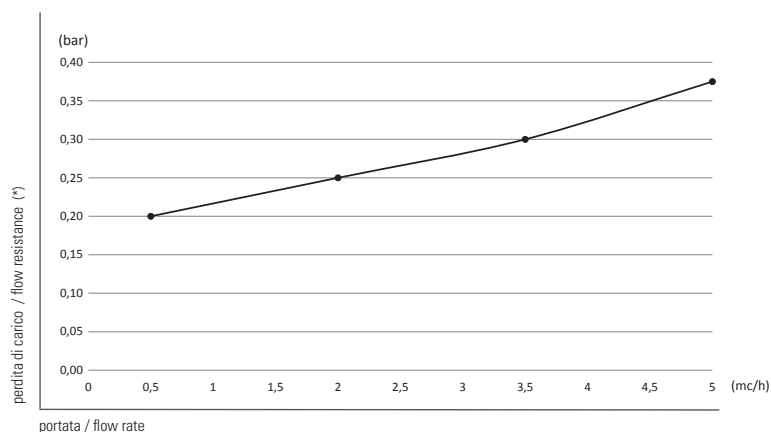

ITA VARIANTI E OPTIONAL | GB VARIANTS AND OPTIONAL

BYPASS

VERSIONE EXTREME / EXTREME VERSION

ON/OFF

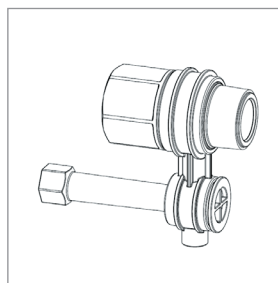

Ulteriori informazioni tecniche disponibili su richiesta
Additional technical information available on request

miXtron